

TEST REPORT

Product Name : DataHub
Model Number : DataHub1000

Prepared for : SOLAX POWER NETWORK TECHNOLOGY (ZHEJIANG)
CO., LTD.

Address : No.288, Shizhu Road, Tonglu Economic Development
Zone, Tonglu City, Zhejiang Province 310000, P. R. China

Prepared by : EMTEK (NINGBO) CO., LTD.
Address : 1F Building 4, 1177#, Lingyun Road, Ningbo National
Hi-Tech Zone, Ningbo, Zhejiang, China.

Tel: +86-574-27907998
Fax: +86-574-27721538

Report Number : ENB2111250113E00801R
Date(s) of Tests : November 25, 2021 to December 03, 2021
Date of issue : December 03, 2021



TABLE OF CONTENT

Test Report Description	Page
1. SUMMARY OF TEST RESULT	5
2. GENERAL INFORMATION.....	6
2.1. Description of Device (EUT).....	6
2.2. Input / Output Ports	6
2.3. Independent Operation Modes.....	6
2.4. Test Manner.....	7
2.5. Description of Test Facility.....	7
2.6. Test Software.....	7
2.7. Support Device.....	8
2.8. Measurement Uncertainty	8
3. MEASURING DEVICE AND TEST EQUIPMENT	9
3.1. For Power Line Conducted Emission Measurement.....	9
3.2. For Conducted Emissions at Telecommunications/network port Measurement	9
3.3. For Radiated Emission Measurement (Up to 1 GHz).....	9
3.4. For Radiated Emission Measurement (Above 1 GHz).....	10
4. CONDUCTED EMISSIONS FROM THE AC MAINS POWER PORTS	11
4.1. Block Diagram of Test Setup	11
4.2. Limits	11
4.3. Test Procedure	11
4.4. Measuring Results.....	12
5. ASYMMETRIC MODE CONDUCTED EMISSIONS AT WIRED NETWORK PORTS	17
5.1. Block Diagram of Test Setup	17
5.2. Limits	17
5.3. Test Procedure	18
5.4. Measuring Results.....	18
6. RADIATED EMISSION MEASUREMENT (UP TO 1GHZ).....	21
6.1. Block Diagram of Test Setup	21
6.2. Radiated Emission Limits	21
6.3. Test Procedure	21
6.4. Measuring Results.....	22
7. RADIATED EMISSION MEASUREMENT (ABOVE 1GHZ).....	27
7.1. Block Diagram of Test Setup	27
7.2. Radiated Limit.....	27
7.3. Test Procedure	28
7.4. Measuring Results.....	28
8. PHOTOGRAPH.....	30
8.1. Photos of Conducted Emissions from the AC Mains Power Ports.....	30
8.2. Photo of Conducted Emissions at Telecommunications/network port Measurement	31
8.3. Photo of Radiation Emission Measurement (UP TO 1GHz)	32
8.4. Photo of Radiation Emission Measurement (Above 1GHz)	33

APPENDIX I (Photos of EUT) (7 Pages)

TEST REPORT DESCRIPTION

Applicant : SOLAX POWER NETWORK TECHNOLOGY (ZHEJIANG) CO., LTD.
Manufacturer : SOLAX POWER NETWORK TECHNOLOGY (ZHEJIANG) CO., LTD.
Trade Mark : SolaX Power
EUT : DataHub
Model No. : DataHub1000
Power Supply : AC 100-240V, 50/60Hz, 24W

Measurement Procedure Used:

AS/NZS CISPR 32:2015+AMD1:2020

The device described above is tested by EMTEK (NINGBO) CO., LTD. to determine the maximum emission levels emanating from the device and the severe levels of the device can endure and its performance criterion. The measurement results are contained in this test report and EMTEK (NINGBO) CO., LTD. is assumed full of responsibility for the accuracy and completeness of these measurements. Also, this report shows that the EUT (Equipment Under Test) is technically compliant with the AS/NZS CISPR 32 requirement.

This report applies to above tested sample only. This report shall not be reproduced in part without written approval of EMTEK (NINGBO) CO., LTD.

Date of Test : November 25, 2021 to December 03, 2021

Prepared by : 
June Gao/Engineer

Reviewer : 
Ade Wang/Supervisor

Approved & Authorized Signer : 
Tony Wei/Manager



Modified History

Version	Report No.	Revision date	Summary
	ENB2111250113E00801R	/	Original Report



1. SUMMARY OF TEST RESULT

EMISSION			
Description of Test Item	Standard	Limits	Results
Conducted emissions from the AC mains power ports	AS/NZS CISPR 32:2015+AMD1:2020	Class B, Table A.10	Pass
Asymmetric mode conducted emissions	Wired network ports	AS/NZS CISPR 32:2015+AMD1:2020	Class B, Table A.12
	Optical fibre ports	AS/NZS CISPR 32:2015+AMD1:2020	Class B, Table A.12
	Broadcast receiver tuner ports	AS/NZS CISPR 32:2015+AMD1:2020	Class B, Table A.12
	Antenna ports	AS/NZS CISPR 32:2015+AMD1:2020	Class B, Table A.12
Conducted differential voltage emissions	TV broadcast receiver tuner ports	AS/NZS CISPR 32:2015+AMD1:2020	Class B, Table A.13
	RF modulator output ports	AS/NZS CISPR 32:2015+AMD1:2020	Class B, Table A.13
	FM broadcast receiver tuner ports	AS/NZS CISPR 32:2015+AMD1:2020	Class B, Table A.13
Radiated emissions at frequencies up to 1 GHz	AS/NZS CISPR 32:2015+AMD1:2020	Class B, Table A.4	Pass
Radiated emissions at frequencies above 1 GHz	AS/NZS CISPR 32:2015+AMD1:2020	Class B, Table A.5	Pass
Radiated emissions from FM receivers	AS/NZS CISPR 32:2015+AMD1:2020	Table A.6	N/A
Outdoor units of home satellite receiving systems	AS/NZS CISPR 32:2015+AMD1:2020	Table A.7	N/A
Note: N/A is an abbreviation for Not Applicable.			

2. GENERAL INFORMATION

2.1. Description of Device (EUT)

EUT : DataHub

Model Number : DataHub1000

Test Voltage : AC 240V/50Hz, AC 120V/60Hz

AC Adapter : M/N: ABT020120A
Input: AC 100-240V, 50/60Hz, 1.5A
Output: DC 12V, 2A, 24W

Highest Frequency : 2480 MHz

Sample Number : 1#

Applicant : SOLAX POWER NETWORK TECHNOLOGY (ZHEJIANG) CO., LTD.

Address : No.288, Shizhu Road, Tonglu Economic Development Zone, Tonglu City, Zhejiang Province 310000, P. R. China

Manufacturer : SOLAX POWER NETWORK TECHNOLOGY (ZHEJIANG) CO., LTD.

Address : No.288, Shizhu Road, Tonglu Economic Development Zone, Tonglu City, Zhejiang Province 310000, P. R. China

Date of Received : November 25, 2021

Date of Test : November 25, 2021 to December 03, 2021

2.2. Input / Output Ports

Port #	Name	Type*	Cable Max. >3m	Cable Shielded	Comments
1	Enclosure	N/E	--	--	None
2	RS485	A/D	--	--	None
3	Net Port	A/D	--	--	None

*Note: Use abbreviations:

AC= AC Power port

DC= DC Power port

N/E= Non-Electrical

A/D=Analogue/digital data port (signal/control port, antenna port, wired network port, broadcast receiver tuner port, optical fibre port)

2.3. Independent Operation Modes

A. ON

2.4. Test Manner

Test Items	Test Voltage	Operation Modes	Worst case
Conducted emissions from the AC mains power ports	AC 240V/50Hz AC 120V/60Hz	Mode A	Mode A
Asymmetric mode conducted emissions	AC 240V/50Hz AC 120V/60Hz	Mode A	Mode A
Radiated emissions at frequencies up to 1 GHz	AC 240V/50Hz AC 120V/60Hz	Mode A	Mode A
Radiated emissions at frequencies above 1 GHz	AC 240V/50Hz AC 120V/60Hz	Mode A	Mode A

2.5. Description of Test Facility

Site Description
EMC Lab.

: **Accredited by CNAS**

The Certificate Registration Number is L6666.

The Laboratory has been assessed and proved to be in compliance with CNAS-CL01:2018 (identical to ISO/IEC 17025:2017)

Accredited by FCC

Designation Number: CN1302

Test Firm Registration Number: 436491

Accredited by A2LA

The certificate is valid until May 31, 2023

Accredited by Industry Canada

The Conformity Assessment Body Identifier is CN0114

Name of Firm : EMTEK (NINGBO) CO., LTD.

Site Location : 1F Building 4, 1177#, Lingyun Road, National Hi-Tech Zone, Ningbo, Zhejiang, China

2.6. Test Software

Item	Software
Conducted Emission	: EZ-EMC (Ver. CON-03A1)
Radiated Emission	: EZ-EMC (Ver. EMEC-3A1)

2.7. Support Device

Notebook : Manufacturer: LENOVO
M/N: T430s
S/N: R9RK4YK

Notebook : Manufacturer: ASUS
M/N: FX80G
S/N: J7NRCX03D694281

Wireless router : Manufacturer: TP-LINK
M/N: TL-WR886N
S/N: 1156004013356

2.8. Measurement Uncertainty

Test Item	Uncertainty
Conducted Emission Uncertainty	2.08dB (9 k-150 kHz)
	2.40dB (150 k-30 MHz)
Radiated Emission Uncertainty (3m Chamber)	: 4.06 dB (Polarize: H) (30MHz-1000MHz)
	4.04 dB (Polarize: V) (30MHz-1000MHz)
	4.82 dB (Polarize: H) (1~18GHz)
	4.80 dB (Polarize: V) (1~18GHz)

3. MEASURING DEVICE AND TEST EQUIPMENT

3.1. For Power Line Conducted Emission Measurement

Item	Equipment	Manufacturer	Model No.	Serial No.	Last Cal.	Cal. Interval
<input checked="" type="checkbox"/>	Test Receiver	Rohde & Schwarz	ESCI	101108	July 08, 2021	1 Year
<input checked="" type="checkbox"/>	L.I.S.N	Rohde & Schwarz	ENV216	101193	July 08, 2021	1 Year
<input checked="" type="checkbox"/>	L.I.S.N	Schwarzbeck	NSLK 8126	8126-462	July 08, 2021	1 Year
<input checked="" type="checkbox"/>	Pulse Limiter	MTS-systemtechnik	IMP-136	2611115-001-0033	July 08, 2021	1 Year
<input checked="" type="checkbox"/>	RF Switching unit	CD	RSU-M2	38400	July 08, 2021	1 Year

3.2. For Conducted Emissions at Telecommunications/network port Measurement

Item	Equipment	Manufacturer	Model No.	Serial No.	Last Cal.	Cal. Interval
<input checked="" type="checkbox"/>	Test Receiver	Rohde & Schwarz	ESCI	101108	July 08, 2021	1 Year
<input checked="" type="checkbox"/>	I.S.N	Tsetq	ISNT8	51926	Jan. 11, 2021	1 Year
<input checked="" type="checkbox"/>	I.S.N	Tsetq	ISNT8-Cat 6	50583	Jan. 11, 2021	1 Year
<input checked="" type="checkbox"/>	Pulse Limiter	MTS-systemtechnik	IMP-136	2611115-001-0033	July 08, 2021	1 Year
<input checked="" type="checkbox"/>	RF Switching unit	CD	RSU-M2	38400	July 08, 2021	1 Year

3.3. For Radiated Emission Measurement (Up to 1 GHz)

Used	Equipment	Manufacturer	Model No.	Serial No.	Last Cal.	Cal. Interval
<input checked="" type="checkbox"/>	Spectrum Analyzer	Rohde & Schwarz	ESCI	101107	July 08, 2021	1 Year
<input checked="" type="checkbox"/>	EMI Test Receiver	Rohde & Schwarz	ESCI	101107	July 08, 2021	1 Year
<input checked="" type="checkbox"/>	Pre-Amplifier	CD	PAP-0203	22015	July 08, 2021	1 Year
<input checked="" type="checkbox"/>	Bilog Antenna	Schwarzbeck	VULB9163	9163-467	July 12, 2020	2 Year
<input checked="" type="checkbox"/>	Cable	Huber + Suhner	CBL3-NN-0.5 M	101216-21405 00-2	July 08, 2021	1 Year
<input checked="" type="checkbox"/>	Cable	Huber + Suhner	CBL3-NN-3.0 M	101216-21430 00-2	July 08, 2021	1 Year
<input checked="" type="checkbox"/>	Cable	Huber + Suhner	CBL3-NN-9.0 M	101216-21490 00	July 08, 2021	1 Year

3.4. For Radiated Emission Measurement (Above 1 GHz)

Used	Equipment	Manufacturer	Model No.	Serial No.	Last Cal.	Cal. Interval
<input checked="" type="checkbox"/>	Spectrum Analyzer	Agilent	E4407B	MY45107013	April 08, 2021	1 Year
<input checked="" type="checkbox"/>	Pre-Amplifier	Connphy Microwave Inc.	GLN-1G40G-4165-K	0319104	Nov 22, 2021	1 Year
<input checked="" type="checkbox"/>	Horn Antenna	Schwarzbeck	BBHA 9120	9120D-707	April 13, 2021	2 Year
<input checked="" type="checkbox"/>	Cable	SMAMSMAM	A50-0.5M	N/A	July 08, 2021	1 Year
<input checked="" type="checkbox"/>	Cable	SMAMSMAM	A50-3M	N/A	July 08, 2021	1 Year
<input checked="" type="checkbox"/>	Cable	SMAMSMAM	A50-6M	N/A	July 08, 2021	1 Year
<input checked="" type="checkbox"/>	Band Reject Filter	O.M.Jones, Inc. db a	BRM50702-0	G049	July 08, 2021	1 Year
<input type="checkbox"/>	Band Reject Filter	COM-MW Technology co., Ltd	ZBSF3-C431.4-436.4-751	07204734	July 08, 2021	1 Year

4. CONDUCTED EMISSIONS FROM THE AC MAINS POWER PORTS

4.1. Block Diagram of Test Setup

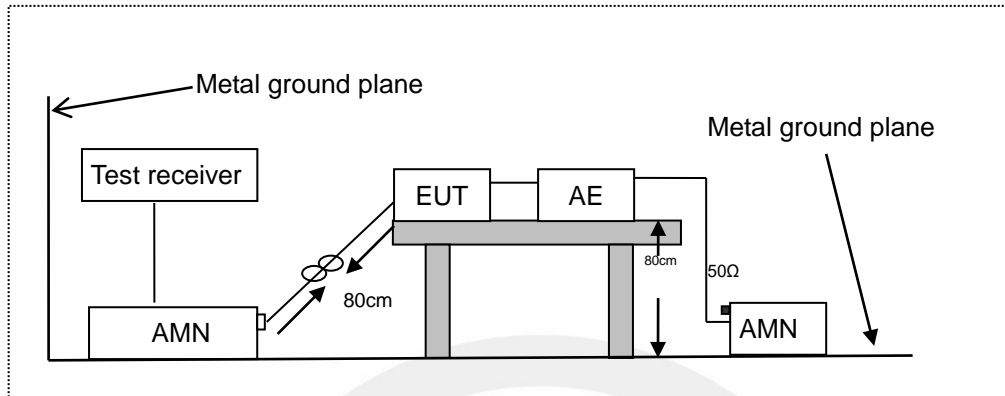

AMN: Artificial Mains Network
 AE: Associated equipment
 EUT: Equipment under test

4.2. Limits

AS/NZS CISPR 32:2015+AMD1:2020, Class B, Table A.10

Frequency (MHz)	Limit (dB μ V)	
	Quasi-peak Level	Average Level
0.15 ~ 0.50	66.0 ~ 56.0 *	56.0 ~ 46.0 *
0.50 ~ 5.00	56.0	46.0
5.00 ~ 30.00	60.0	50.0

NOTE1-The lower limit shall apply at the transition frequencies.
 NOTE2-The limit decreases linearly with the logarithm of the frequency in the range 0.15MHz to 0.50MHz.

4.3. Test Procedure

The EUT was placed on a desk 0.8 m height from the metal ground plane and 0.4 m from the conducting wall of the shielding room and it was kept at least 0.8 m from any other grounded conducting surface. The size of the table will nominally be 1.5 m x1.0 m.

The rear of the arrangement shall be flush with the back of the supporting tabletop unless that would not be possible or typical of normal use.

All units of equipment forming the system under test (includes the EUT as well as connected peripherals and associated equipment or devices) shall be arranged such that a nominal 0.1 m separation is achieved between the neighboring units.

Connect EUT to the power mains through a artificial mains network (AMN). Where the mains cable supplied by the manufacturer is longer than 1 m, the excess should be folded at the centre into a bundle no longer than 0.4 m, so that its length is shortened to 1 m.

All the support units are connecting to the other AMN.
The AMN provides 50 ohm coupling impedance for the measuring instrument.
The CISPR states that the AMN with 50 ohm and 50 microhenry should be used.
Both sides of AC line were checked for maximum conducted interference.

The frequency range from 150 kHz to 30 MHz was sweep.

Set the test-receiver system to quasi peak detect function and average detect function, and to measure the conducted emissions values.

Test results were obtained from the following equation:
Measurement (dB μ V) = Correct Factor (dB) + Reading (dB μ V)
Over (dB) = Measurement (dB μ V) - Limit (dB μ V)

4.4. Measuring Results

Pass.

Please refer to the following pages.

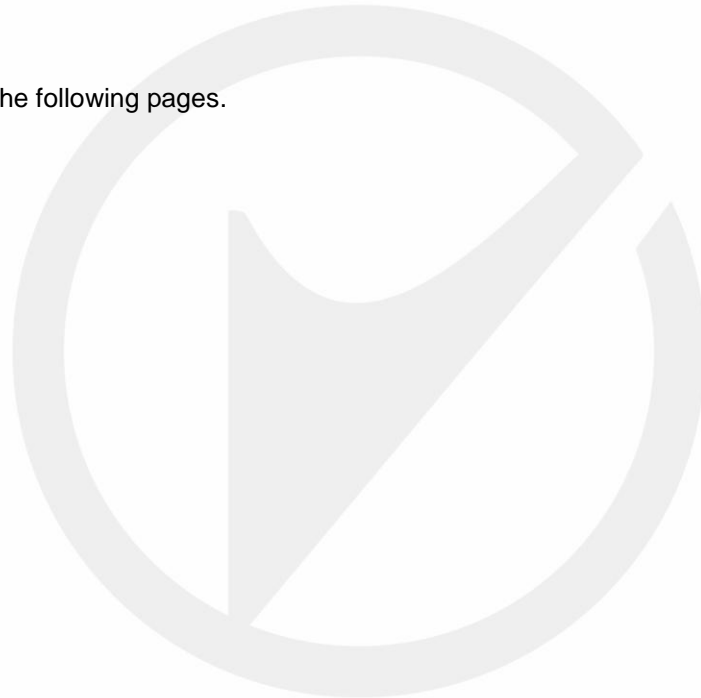

Test Data:

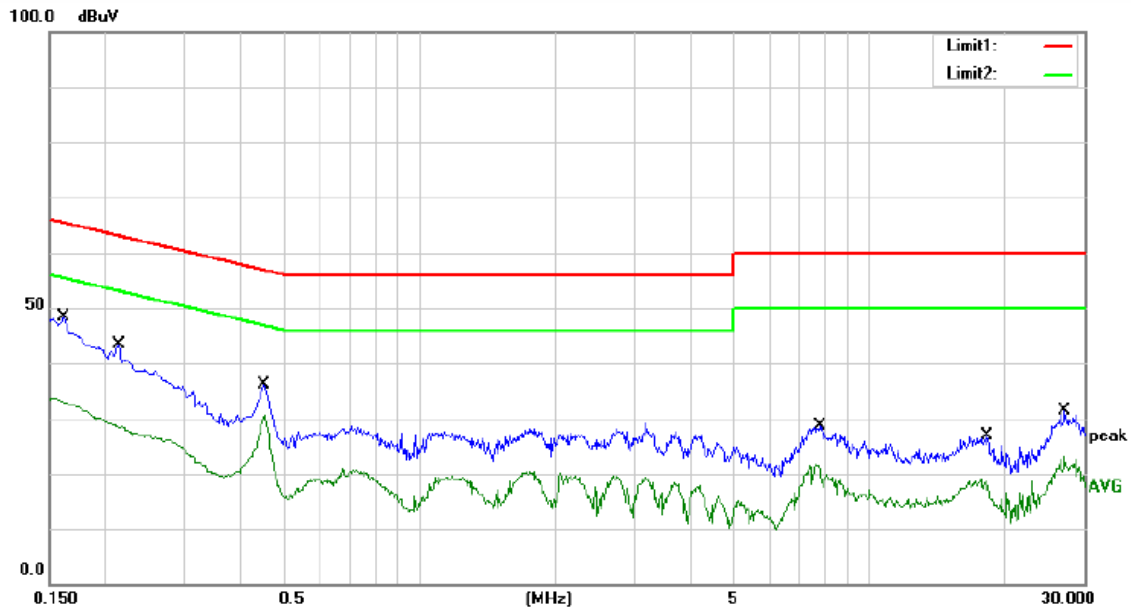

Site site #1 Phase: **L1** Temperature: 24
 Limit: (CE)AS/NZS CISPR 32 class B_QP Power: AC 240V/50Hz Humidity: 50 %
 Mode: ON
 Note:

No.	Mk.	Freq. MHz	Reading Level dBuV	Correct Factor dB	Measure- ment dBuV	Limit dBuV	Over dB	Detector	Comment
1		0.1620	38.10	10.10	48.20	65.36	-17.16	QP	
2		0.1620	22.80	10.10	32.90	55.36	-22.46	AVG	
3		0.2140	33.20	10.09	43.29	63.05	-19.76	QP	
4		0.2140	18.20	10.09	28.29	53.05	-24.76	AVG	
5		0.4500	25.90	10.07	35.97	56.88	-20.91	QP	
6	*	0.4500	20.30	10.07	30.37	46.88	-16.51	AVG	
7		7.7280	18.20	10.42	28.62	60.00	-31.38	QP	
8		7.7280	9.10	10.42	19.52	50.00	-30.48	AVG	
9		18.2440	16.20	10.59	26.79	60.00	-33.21	QP	
10		18.2440	7.90	10.59	18.49	50.00	-31.51	AVG	
11		27.1600	20.60	10.76	31.36	60.00	-28.64	QP	
12		27.1600	12.40	10.76	23.16	50.00	-26.84	AVG	

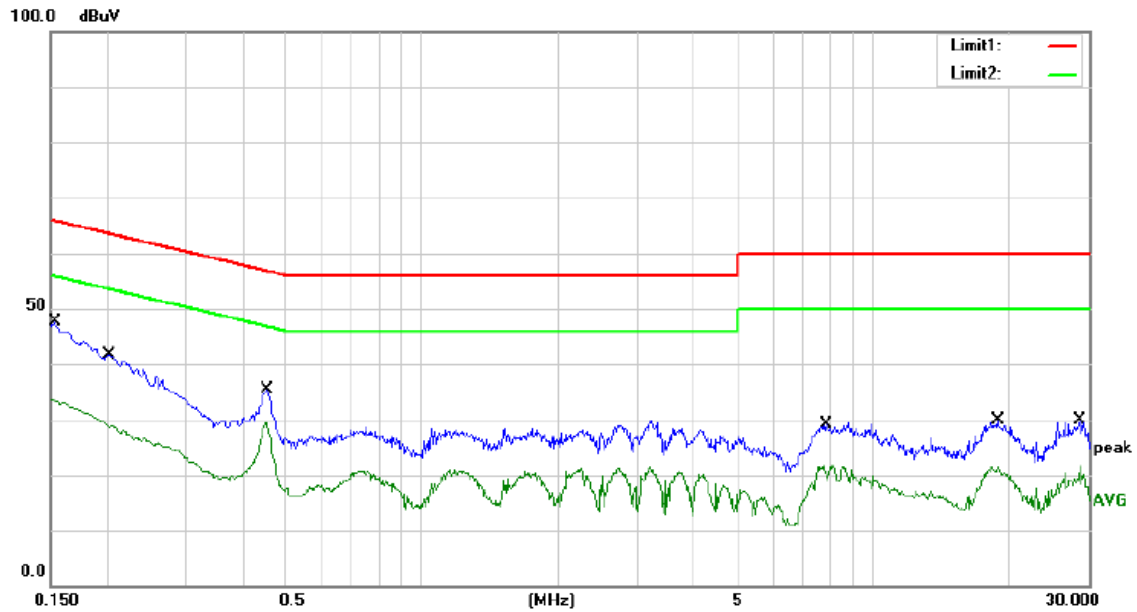

Site site #1 Phase: **N** Temperature: 24
 Limit: (CE)AS/NZS CISPR 32 class B_QP Power: AC 240V/50Hz Humidity: 50 %
 Mode: ON
 Note:

No.	Mk.	Freq. MHz	Reading Level dBuV	Correct Factor dB	Measure- ment dBuV	Limit dBuV	Over dB	Detector	Comment
1		0.1540	37.50	10.08	47.58	65.78	-18.20	QP	
2	*	0.1540	31.60	10.08	41.68	55.78	-14.10	AVG	
3		0.2020	31.60	10.08	41.68	63.53	-21.85	QP	
4		0.2020	18.00	10.08	28.08	53.53	-25.45	AVG	
5		0.4540	25.20	10.11	35.31	56.80	-21.49	QP	
6		0.4540	19.20	10.11	29.31	46.80	-17.49	AVG	
7		7.8700	18.60	10.45	29.05	60.00	-30.95	QP	
8		7.8700	9.60	10.45	20.05	50.00	-29.95	AVG	
9		18.9180	19.10	10.65	29.75	60.00	-30.25	QP	
10		18.9180	10.20	10.65	20.85	50.00	-29.15	AVG	
11		28.6860	19.00	10.41	29.41	60.00	-30.59	QP	
12		28.6860	11.10	10.41	21.51	50.00	-28.49	AVG	

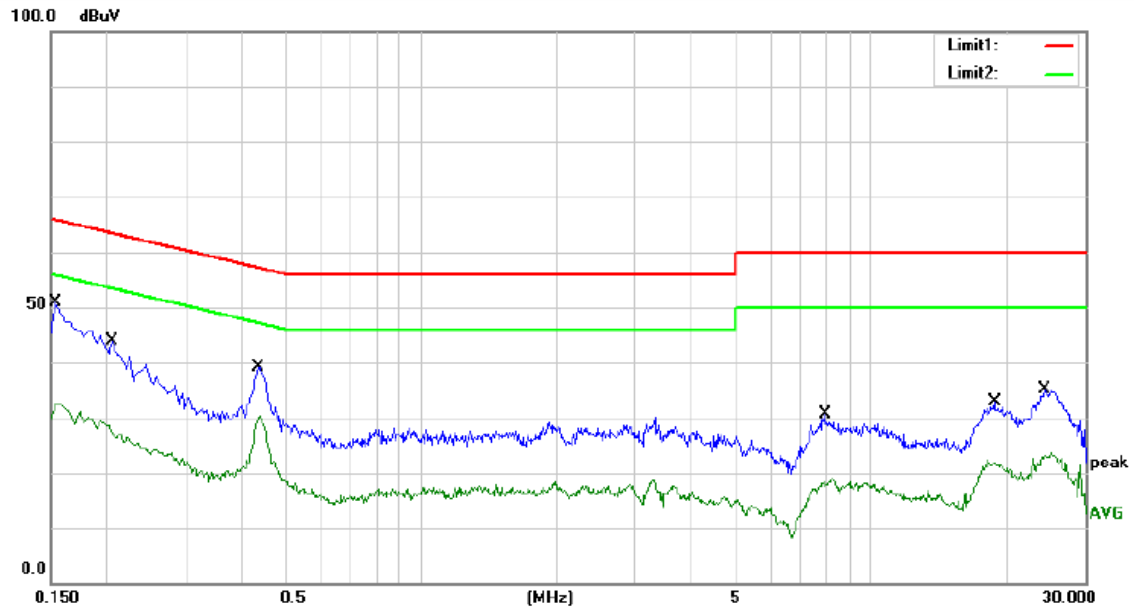

Site site #1 Phase: **N** Temperature: 24
 Limit: (CE)AS/NZS CISPR 32 class B_QP Power: AC 120V/60Hz Humidity: 50 %
 Mode: ON
 Note:

No.	Mk.	Freq. MHz	Reading Level dBuV	Correct Factor dB	Measure- ment dBuV	Limit dBuV	Over dB	Detector	Comment
1	*	0.1540	40.80	10.08	50.88	65.78	-14.90	QP	
2		0.1540	22.40	10.08	32.48	55.78	-23.30	AVG	
3		0.2060	33.70	10.08	43.78	63.37	-19.59	QP	
4		0.2060	17.00	10.08	27.08	53.37	-26.29	AVG	
5		0.4340	29.10	10.10	39.20	57.18	-17.98	QP	
6		0.4340	19.90	10.10	30.00	47.18	-17.18	AVG	
7		7.9220	20.10	10.45	30.55	60.00	-29.45	QP	
8		7.9220	7.20	10.45	17.65	50.00	-32.35	AVG	
9		18.9140	22.10	10.65	32.75	60.00	-27.25	QP	
10		18.9140	10.80	10.65	21.45	50.00	-28.55	AVG	
11		24.2900	24.40	10.54	34.94	60.00	-25.06	QP	
12		24.2900	12.70	10.54	23.24	50.00	-26.76	AVG	

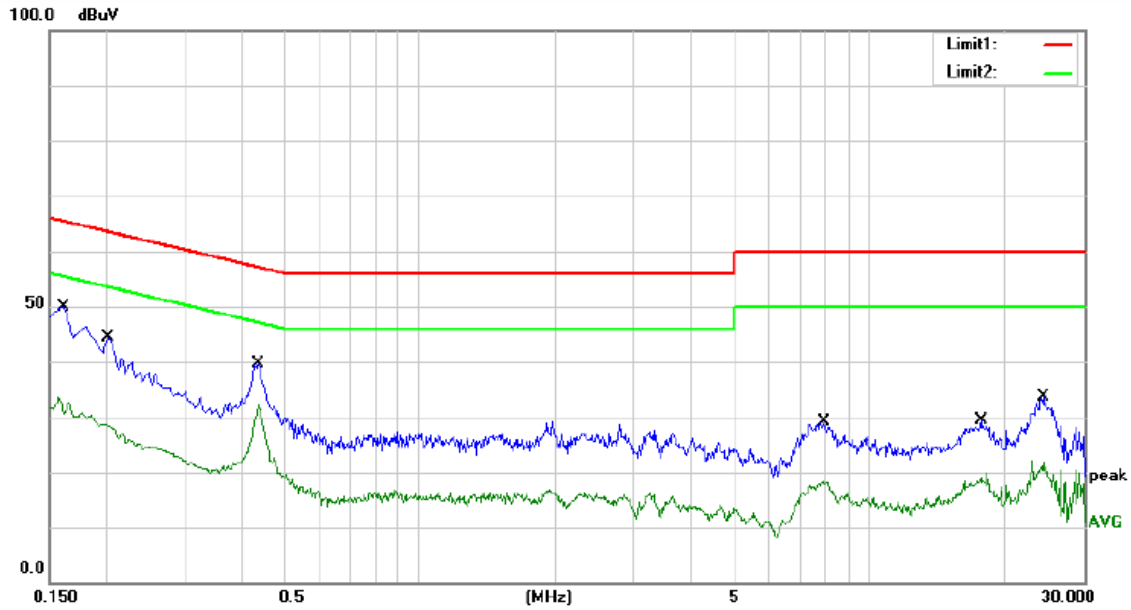

Site site #1 Phase: **L1** Temperature: 24
 Limit: (CE)AS/NZS CISPR 32 class B_QP Power: AC 120V/60Hz Humidity: 50 %
 Mode: ON
 Note:

No.	Mk.	Freq. MHz	Reading Level dBuV	Correct Factor dB	Measure- ment dBuV	Limit dBuV	Over dB	Detector	Comment
1		0.1620	39.80	10.10	49.90	65.36	-15.46	QP	
2		0.1620	20.50	10.10	30.60	55.36	-24.76	AVG	
3		0.2020	34.20	10.09	44.29	63.53	-19.24	QP	
4		0.2020	18.30	10.09	28.39	53.53	-25.14	AVG	
5		0.4380	29.60	10.07	39.67	57.10	-17.43	QP	
6	*	0.4380	22.00	10.07	32.07	47.10	-15.03	AVG	
7		7.9580	18.60	10.43	29.03	60.00	-30.97	QP	
8		7.9580	7.30	10.43	17.73	50.00	-32.27	AVG	
9		17.6940	18.60	10.58	29.18	60.00	-30.82	QP	
10		17.6940	7.40	10.58	17.98	50.00	-32.02	AVG	
11		24.3500	22.90	10.70	33.60	60.00	-26.40	QP	
12		24.3500	10.40	10.70	21.10	50.00	-28.90	AVG	

5. ASYMMETRIC MODE CONDUCTED EMISSIONS AT WIRED NETWORK PORTS

5.1. Block Diagram of Test Setup

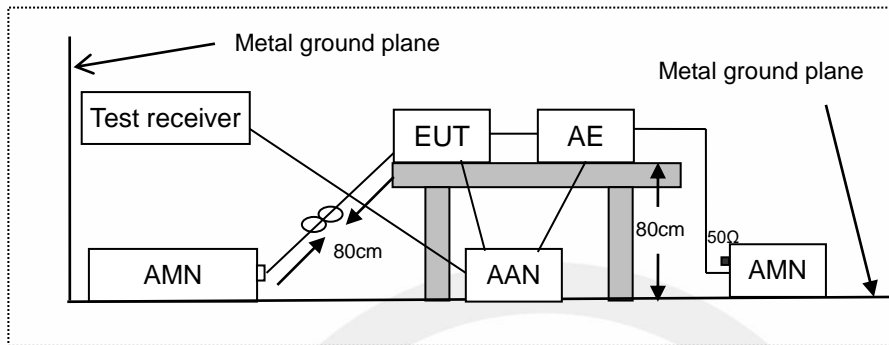

AMN: Artificial mains network
 AE: Associated equipment
 EUT: Equipment under test
 AAN: Asymmetric artificial network

5.2. Limits

AS/NZS CISPR 32:2015+AMD1:2020, Class B, Table A.12

Frequency range (MHz)	Coupling device (see Table A.8)	Detector type / bandwidth	Class B voltage limits dB(μV)	Class B current limits dB(μA)
0.15 to 0.5	AAN	Quasi Peak / 9 kHz	84 to 74	N/A
0.5 to 30			74	
0.15 to 0.5	AAN	Average / 9 kHz	74 to 64	
0.5 to 30			64	
0.15 to 0.5	CVP and current probe	Quasi Peak / 9 kHz	84 to 74	40 to 30
0.5 to 30			74	30
0.15 to 0.5	CVP and current probe	Average / 9 kHz	74 to 64	30 to 20
0.5 to 30			64	20
0.15 to 0.5	Current Probe	Quasi Peak / 9 kHz	N/A	40 to 30
0.5 to 30				30
0.15 to 0.5	Current Probe	Average / 9 kHz		30 to 20
0.5 to 30				20

5.3. Test Procedure

The EUT is put on the plane 0.8m high above the ground by insulating support and connected to the AC mains through artificial mains network(AMN) or connected to the wired network port through an asymmetric artificial network(ANN). AMN provided a 50ohm coupling impedance for the tested equipment AC mains port, ANN provided a common mode (asymmetric mode) impedance of 150 Ω to the wired network port under test. Both sides of AC line and the wired network line are investigated to find out the maximum conducted emission according to the EN 55032 regulations during conducted emission measurement.

The bandwidth of the receiver is set at 9 kHz in 150 kHz~30 MHz. The frequency range from 150 kHz to 30 MHz is investigated.

Test results were obtained from the following equation:

Measurement (dB μ V) =Correct Factor (dB) + Reading (dB μ V)

Over (dB) = Measurement (dB μ V) - Limit (dB μ V)

5.4. Measuring Results

Pass.

Please refer to the following pages.

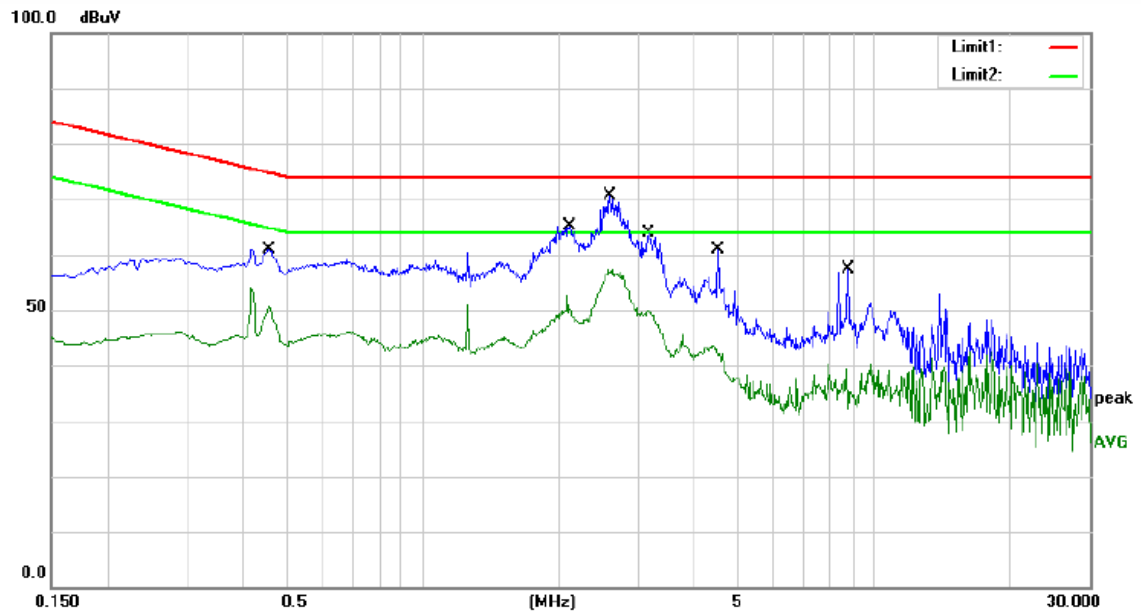

Site site #1 Phase: Temperature: 24
 Limit: (CE)AS/NZS CISPR 32 Class B TELECOM_QP Power: AC 240V/50Hz Humidity: 50 %
 Mode: ON
 Note:

No.	Mk.	Freq. MHz	Reading Level dBuV	Correct Factor dB	Measure- ment dBuV	Limit dBuV	Over dB	Detector	Comment
1		0.4580	35.90	19.84	55.74	74.73	-18.99	QP	
2		0.4580	30.30	19.84	50.14	64.73	-14.59	AVG	
3		2.1140	39.80	19.67	59.47	74.00	-14.53	QP	
4		2.1140	30.10	19.67	49.77	64.00	-14.23	AVG	
5		2.5980	45.20	19.71	64.91	74.00	-9.09	QP	
6	*	2.5980	36.90	19.71	56.61	64.00	-7.39	AVG	
7		3.1620	37.40	19.75	57.15	74.00	-16.85	QP	
8		3.1620	29.80	19.75	49.55	64.00	-14.45	AVG	
9		4.5140	28.40	19.85	48.25	74.00	-25.75	QP	
10		4.5140	21.90	19.85	41.75	64.00	-22.25	AVG	
11		8.7460	24.50	19.90	44.40	74.00	-29.60	QP	
12		8.7460	19.40	19.90	39.30	64.00	-24.70	AVG	

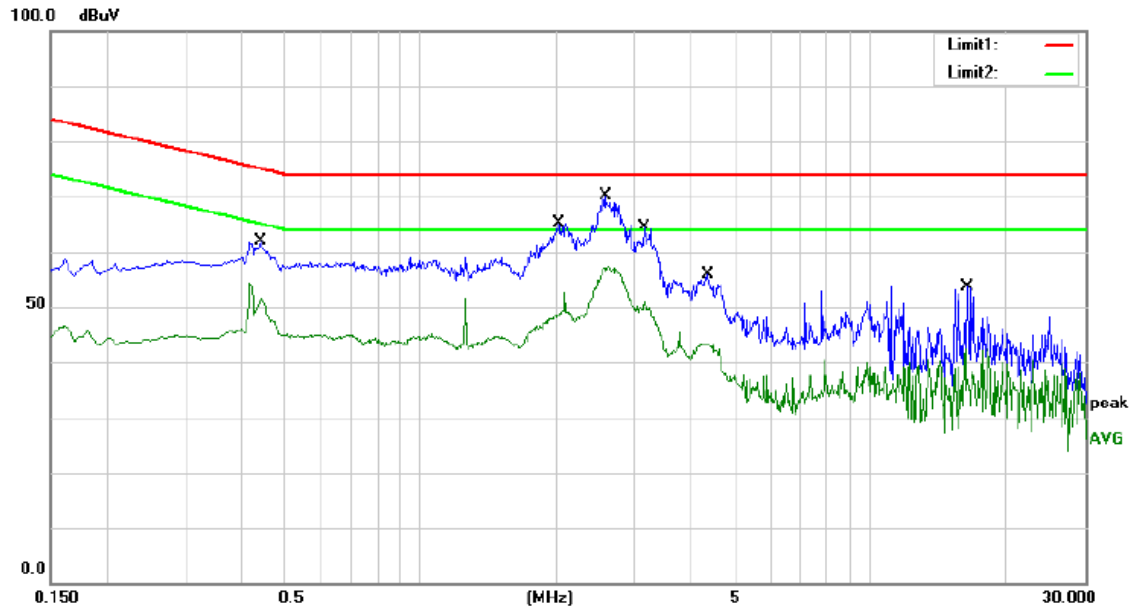

Site site #1 Phase: Temperature: 24
 Limit: (CE)AS/NZS CISPR 32 Class B TELECOM_QP Power: AC 120V/60Hz Humidity: 50 %
 Mode: ON
 Note:

No.	Mk.	Freq.	Reading Level	Correct Factor	Measurement	Limit	Over	Detector	Comment
		MHz	dBuV	dB	dBuV	dBuV	dB		
1		0.4420	36.50	19.84	56.34	75.02	-18.68	QP	
2		0.4420	31.70	19.84	51.54	65.02	-13.48	AVG	
3		2.0260	38.40	19.66	58.06	74.00	-15.94	QP	
4		2.0260	28.80	19.66	48.46	64.00	-15.54	AVG	
5		2.5780	45.50	19.70	65.20	74.00	-8.80	QP	
6	*	2.5780	36.90	19.70	56.60	64.00	-7.40	AVG	
7		3.1500	37.60	19.75	57.35	74.00	-16.65	QP	
8		3.1500	30.20	19.75	49.95	64.00	-14.05	AVG	
9		4.3460	29.70	19.84	49.54	74.00	-24.46	QP	
10		4.3460	23.10	19.84	42.94	64.00	-21.06	AVG	
11		16.4740	21.40	19.91	41.31	74.00	-32.69	QP	
12		16.4740	17.30	19.91	37.21	64.00	-26.79	AVG	

6. RADIATED EMISSION MEASUREMENT (UP TO 1GHz)

6.1. Block Diagram of Test Setup

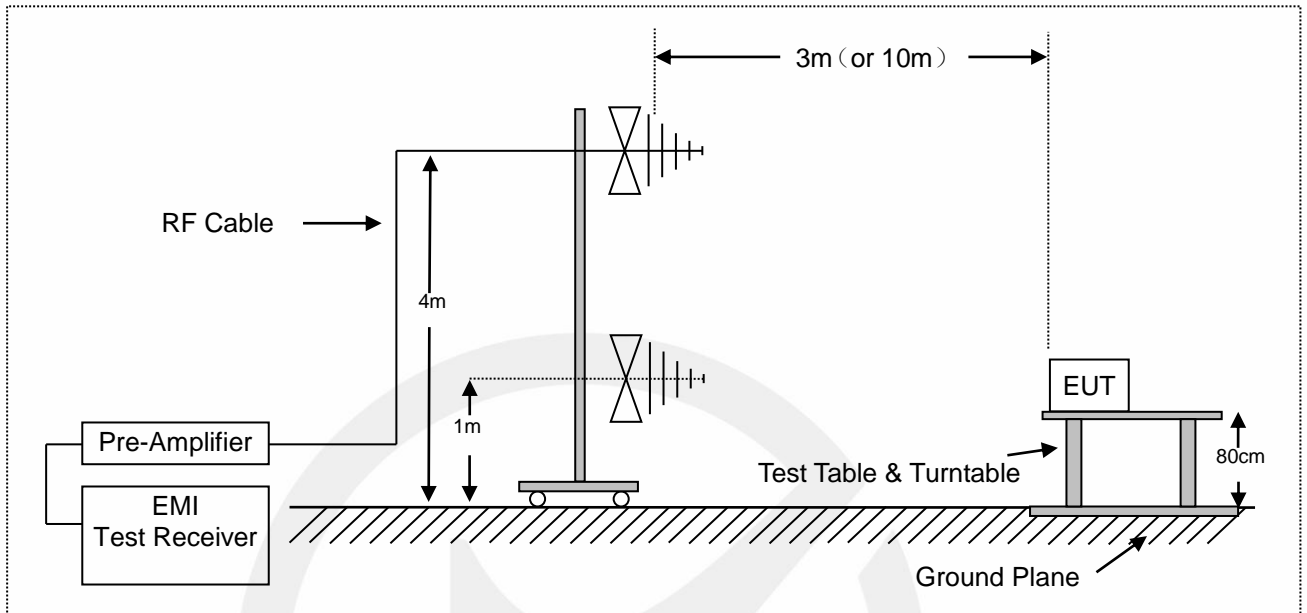

6.2. Radiated Emission Limits

AS/NZS CISPR 32:2015+AMD1:2020, Class B, Table A.4

Frequency range MHz	Measurement			Class B limits dB(μV/m)
	Facility	Distance (m)	Detector type / bandwidth	
30 to 230	OATS/SAC	10	Quasi Peak / 120 kHz	30
230 to 1 000				37
30 to 230	OATS/SAC	3		40
230 to 1 000				47

6.3. Test Procedure

The EUT was placed on a non-conductive table whose total height equaled 80cm. All units of equipment forming the system under test (includes the EUT as well as connected peripherals and associated equipment or devices) shall be arranged such that a nominal 0.1 m separation is achieved between the neighboring units. Where the mains cable supplied by the manufacturer is longer than 1 m, the excess should be folded at the centre into a bundle no longer than 0.4 m, so that its length is shortened to 1 m.

The EUT was set 3 meters (or 10 meters) away from the receiving antenna that was mounted on a non-conductive mast. The antenna can move up and down between 1 to 4 meters to find out the maximum emission level.

The turntable can rotate 360 degree to determine the position of the maximum emission level.

The initial testing identified the frequency that has the highest disturbance relative to the limit while operating the EUT in typical modes of operation and cable positions in a test setup representative of typical system configuration.

The identification of the frequency of highest emission with respect to the limit was found by investigating emissions at a number of significant frequencies. The probable frequency of maximum emission had been found and that the associated cable and EUT configuration and mode of operation had been identified.

The bandwidth of the Receiver is set at 120 kHz.

Test results were obtained from the following equation:

Measurement (dB μ V) = Correct Factor (dB) + Reading (dB μ V)

Over (dB) = Measurement (dB μ V) - Limit (dB μ V)

6.4. Measuring Results

Pass.

Please refer to the following pages.

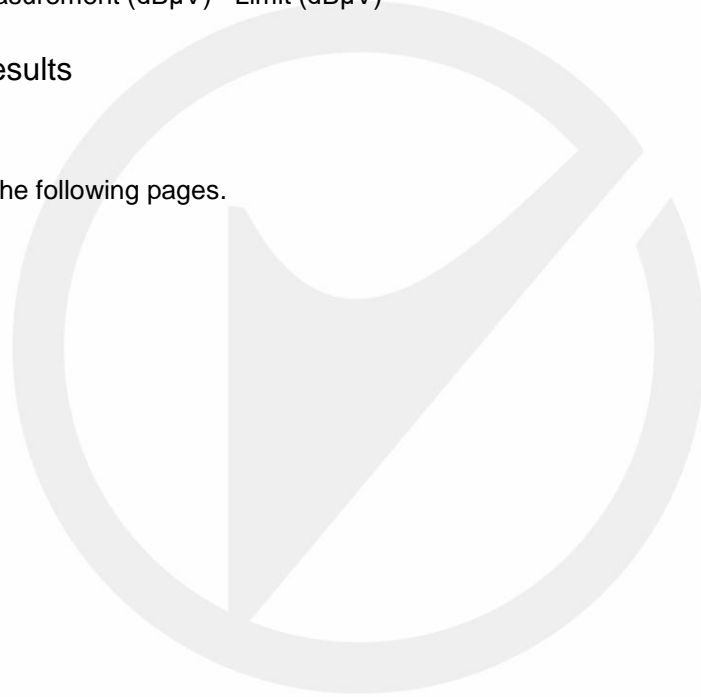

Test Data:

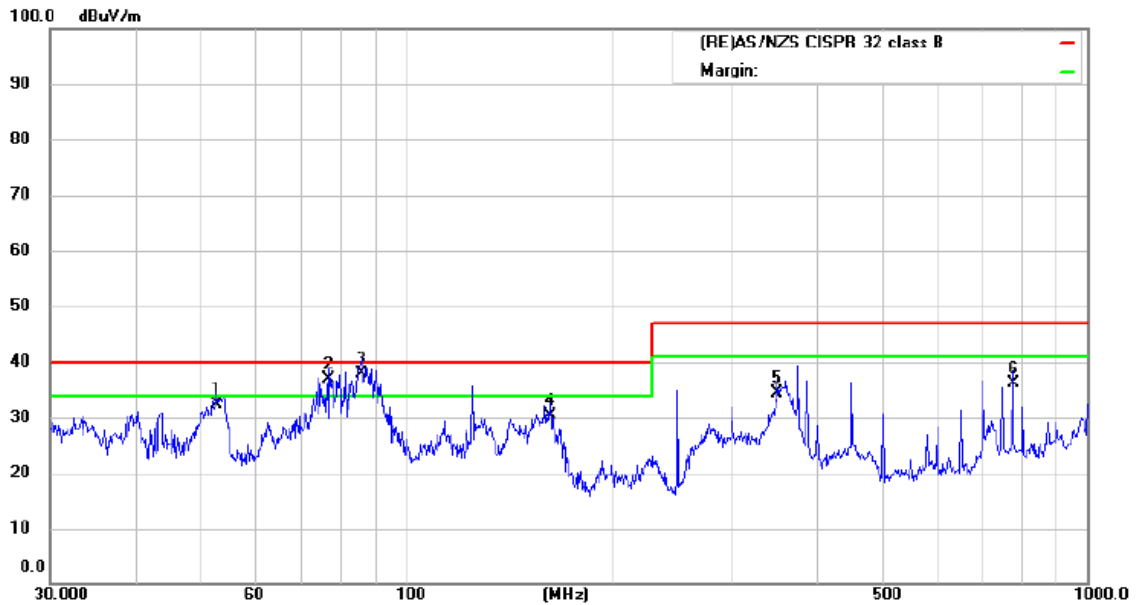

Site Radiated Emission 3m #1 Polarization: *Vertical* Temperature: 24
 Limit: (RE)AS/NZS CISPR 32 class B Power: AC 120V/60Hz Humidity: 55 %
 Mode: ON
 Note:

No.	Mk.	Freq.	Reading Level	Correct Factor	Measurement	Limit	Over	Antenna Height	Table Degree	
		MHz	dBuV	dB	dBuV/m	dBuV/m	dB	cm	degree	Comment
1		52.5752	53.52	-21.02	32.50	40.00	-7.50	QP		
2	!	77.0503	64.20	-27.40	36.80	40.00	-3.20	QP		
3	*	85.8984	64.37	-26.47	37.90	40.00	-2.10	QP		
4		162.6105	57.28	-26.98	30.30	40.00	-9.70	QP		
5		350.4766	54.07	-19.57	34.50	47.00	-12.50	QP		
6		776.8777	45.86	-9.66	36.20	47.00	-10.80	QP		

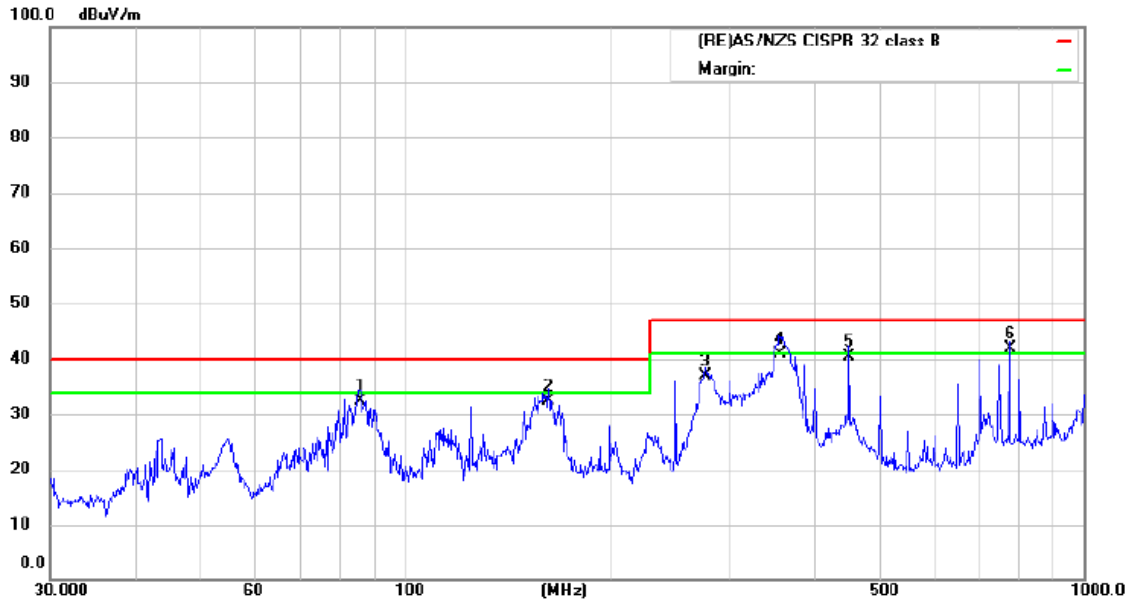

Site Radiated Emission 3m #1

Polarization: *Horizontal*

Temperature: 24

Limit: (RE)AS/NZS CISPR 32 class B

Power: AC 120V/60Hz

Humidity: 55 %

Mode: ON

Note:

No.	Mk.	Freq.	Reading Level	Correct Factor	Measurement	Limit	Over	Antenna Height	Table Degree	
		MHz	dBuV	dB	dBuV/m	dBuV/m	dB	cm	degree	Comment
1		85.8983	58.97	-26.47	32.50	40.00	-7.50	QP		
2		162.6105	59.38	-26.98	32.40	40.00	-7.60	QP		
3		277.0935	57.43	-20.63	36.80	47.00	-10.20	QP		
4		355.4273	60.50	-19.50	41.00	47.00	-6.00	QP		
5		451.1349	58.63	-18.33	40.30	47.00	-6.70	QP		
6	*	776.8778	51.56	-9.66	41.90	47.00	-5.10	QP		

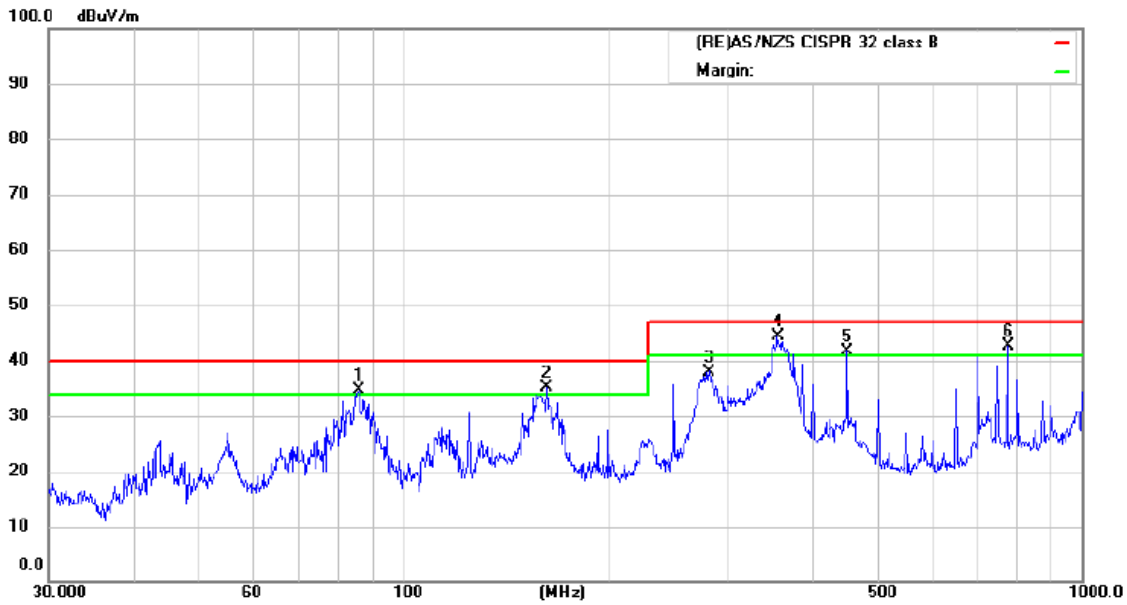

Site Radiated Emission 3m #1

Polarization: **Horizontal**

Temperature: 24

Limit: (RE)AS/NZS CISPR 32 class B

Power: AC 240V/50Hz

Humidity: 55 %

Mode: ON

Note:

No.	Mk.	Freq. MHz	Reading Level dBuV	Correct Factor dB	Measure- ment dBuV/m	Limit dBuV/m	Over dB	Detector	Antenna Height cm	Table Degree degree	Comment
1	!	85.8983	61.17	-26.47	34.70	40.00	-5.30	QP			
2	!	162.6105	62.08	-26.98	35.10	40.00	-4.90	QP			
3		281.9945	58.59	-20.59	38.00	47.00	-9.00	QP			
4	*	355.4273	63.90	-19.50	44.40	47.00	-2.60	QP			
5	!	451.1349	59.93	-18.33	41.60	47.00	-5.40	QP			
6	!	776.8777	52.36	-9.66	42.70	47.00	-4.30	QP			

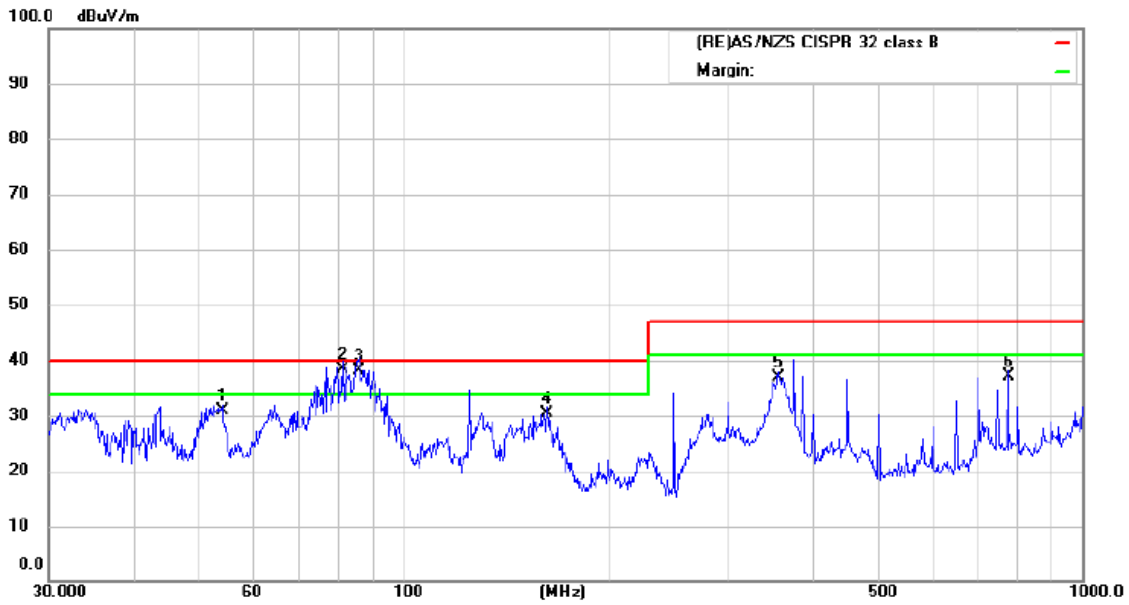

Site Radiated Emission 3m #1

Polarization: *Vertical*

Temperature: 24

Limit: (RE)AS/NZS CISPR 32 class B

Power: AC 240V/50Hz

Humidity: 55 %

Mode: ON

Note:

No.	Mk.	Freq.	Reading Level	Correct Factor	Measurement	Limit	Over	Antenna Height	Table Degree	
		MHz	dBuV	dB	dBuV/m	dBuV/m	dB	cm	degree	Comment
1		54.0709	51.83	-21.03	30.80	40.00	-9.20	QP		
2	*	81.2116	65.78	-27.48	38.30	40.00	-1.70	QP		
3	!	85.8984	64.57	-26.47	38.10	40.00	-1.90	QP		
4		162.6105	57.28	-26.98	30.30	40.00	-9.70	QP		
5		356.6757	56.28	-19.48	36.80	47.00	-10.20	QP		
6		776.8777	46.86	-9.66	37.20	47.00	-9.80	QP		

7. RADIATED EMISSION MEASUREMENT (ABOVE 1GHz)

7.1. Block Diagram of Test Setup

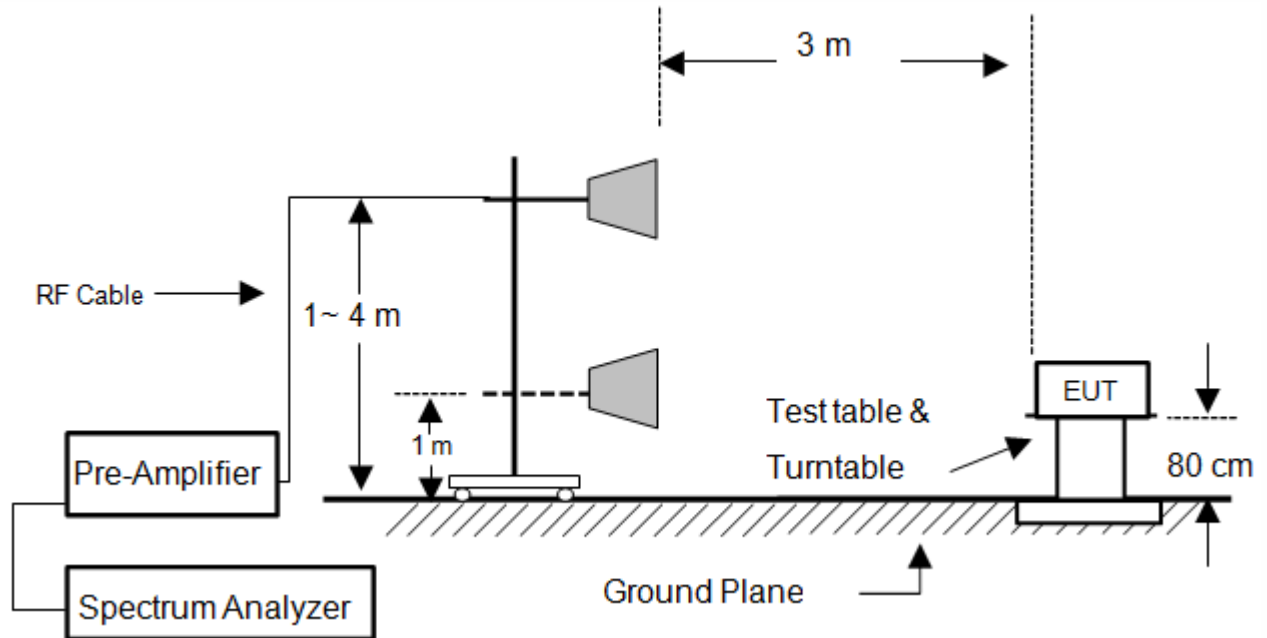

7.2. Radiated Limit

AS/NZS CISPR 32:2015+AMD1:2020, Class B, Table A.5

Frequency range (MHz)	Measurement			Class B limits dB(μ V/m)
	Facility	Distance (m)	Detector type/ bandwidth	
1000 to 6000	FSOATS	3	Average / 1 MHz	54
1000 to 6000			Peak / 1 MHz	74

Note: The highest internal source of an EUT is defined as the highest frequency generated or used within the EUT or on which the EUT operates or tunes. If the highest frequency of the internal sources of the EUT is less than 108 MHz, the measurement shall only be made up to 1 GHz. If the highest frequency of the internal sources of the EUT is between 108 MHz and 500 MHz the measurement shall only be made up to 2 GHz. If the highest frequency of the internal sources of the EUT is between 500 MHz and 1 GHz, the measurement shall only be made up to 5 GHz. If the highest frequency of the internal sources of the EUT is above 1 GHz, the measurement shall be made up to 5 times the highest frequency or 6 GHz, whichever is less.

7.3. Test Procedure

The EUT was placed on a non-conductive table whose total height equaled 80cm. All units of equipment forming the system under test (includes the EUT as well as connected peripherals and associated equipment or devices) shall be arranged such that a nominal 0.1 m separation is achieved between the neighboring units. Where the mains cable supplied by the manufacturer is longer than 1 m, the excess should be folded at the centre into a bundle no longer than 0.4 m, so that its length is shortened to 1 m.

The EUT was set 3 meters away from the receiving antenna that was mounted on a non-conductive mast. The antenna can move up and down between 1 to 4 meters to find out the maximum emission level.

The turntable can rotate 360 degree to determine the position of the maximum emission level.

The initial testing identified the frequency that has the highest disturbance relative to the limit while operating the EUT in typical modes of operation and cable positions in a test setup representative of typical system configuration.

The identification of the frequency of highest emission with respect to the limit was found by investigating emissions at a number of significant frequencies. The probable frequency of maximum emission had been found and that the associated cable and EUT configuration and mode of operation had been identified.

The frequency range above 1 GHz the measuring instrument use RBW=1 MHz and VBW=3 MHz.

Test results were obtained from the following equation:

Measurement (dB μ V) = Correct Factor (dB) + Reading (dB μ V)

Over (dB) = Measurement (dB μ V) - Limit (dB μ V)

7.4. Measuring Results

Pass.

Please refer to the following pages.

■ Radiated Emission Above 1GHz

Test mode: ON Humidity: 55%
 Temperature: 24°C Test Voltage: AC 240V/50Hz
 Test Date: 2021-11-29

Freq. (MHz)	Ant.Pol. H/V	Emission Level(dBuV/m)		Limit 3m(dBuV/m)		Over(dB)	
		PK	AV	PK	AV	PK	AV
4049.020	V	44.10	36.20	74.00	54.00	-29.90	-17.80
4264.706	V	45.10	35.90	74.00	54.00	-28.90	-18.10
4975.490	V	47.80	39.60	74.00	54.00	-26.20	-14.40
5137.255	V	47.40	38.70	74.00	54.00	-26.60	-15.30
5583.333	V	48.30	39.60	74.00	54.00	-25.70	-14.40
5833.333	V	47.60	38.70	74.00	54.00	-26.40	-15.30
3426.470	H	44.30	35.20	70.00	50.00	-29.70	-18.80
4044.118	H	46.70	37.80	70.00	50.00	-27.30	-16.20
4818.627	H	47.40	38.60	70.00	50.00	-26.60	-15.40
5303.922	H	49.80	40.10	70.00	50.00	-24.20	-13.90
5421.569	H	50.40	41.30	70.00	50.00	-23.60	-12.70
5622.549	H	49.20	40.10	74.00	54.00	-24.80	-13.90

Test mode: ON Humidity: 55%
 Temperature: 24°C Test Voltage: AC 120V/60Hz
 Test Date: 2021-11-29

Freq. (MHz)	Ant.Pol. H/V	Emission Level(dBuV/m)		Limit 3m(dBuV/m)		Over(dB)	
		PK	AV	PK	AV	PK	AV
2313.725	V	39.10	35.10	70.00	50.00	-30.90	-14.90
2936.274	V	39.90	34.20	70.00	50.00	-30.10	-15.80
3598.039	V	40.00	33.50	74.00	54.00	-34.00	-20.50
4049.020	V	41.60	36.20	74.00	54.00	-32.40	-17.80
4774.510	V	41.60	34.30	74.00	54.00	-32.40	-19.70
5500.000	V	46.70	38.10	74.00	54.00	-27.30	-15.90
2759.804	H	42.90	37.60	70.00	50.00	-27.10	-12.40
3367.647	H	43.00	38.60	74.00	54.00	-31.00	-15.40
3857.843	H	43.70	37.60	74.00	54.00	-30.30	-16.40
4534.314	H	44.50	38.10	74.00	54.00	-29.50	-15.90
4897.059	H	45.90	39.10	74.00	54.00	-28.10	-14.90
5372.549	H	46.90	39.70	74.00	54.00	-27.10	-14.30

8. PHOTOGRAPH

8.1. Photos of Conducted Emissions from the AC Mains Power Ports

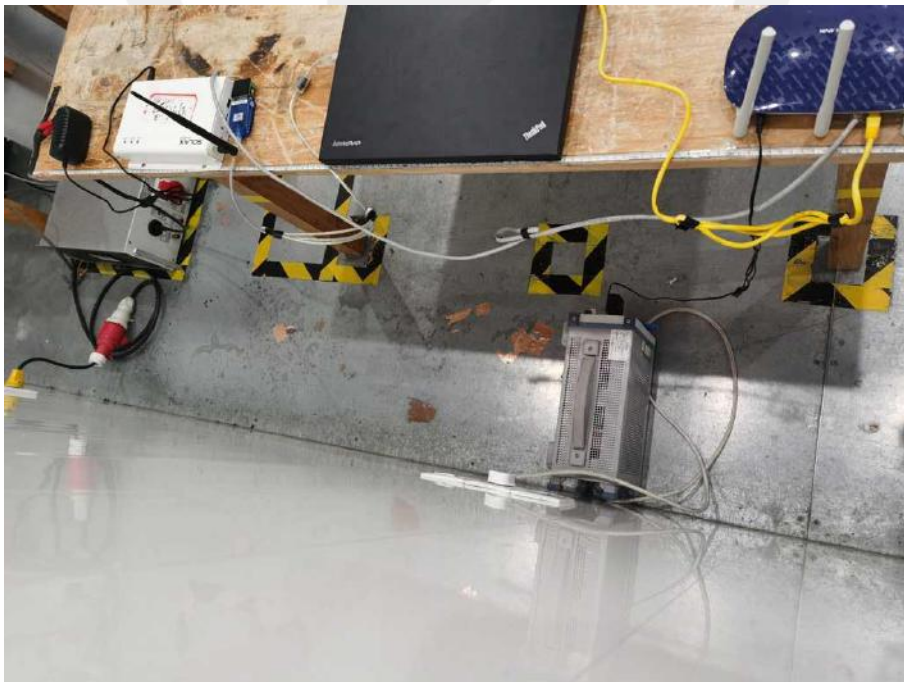
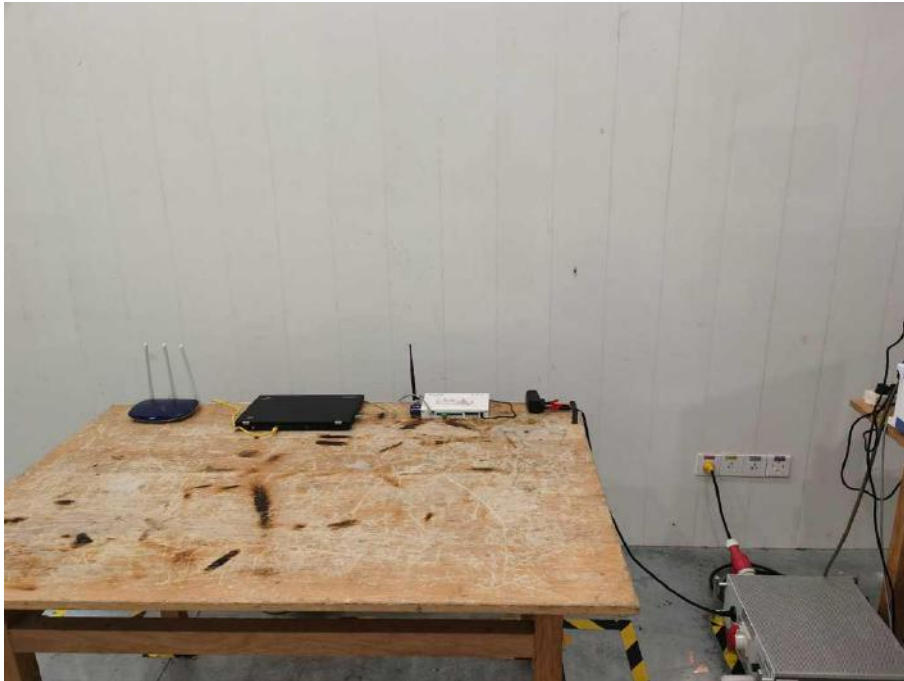

8.2. Photo of Conducted Emissions at Telecommunications/network port Measurement



8.3. Photo of Radiation Emission Measurement (UP TO 1GHz)

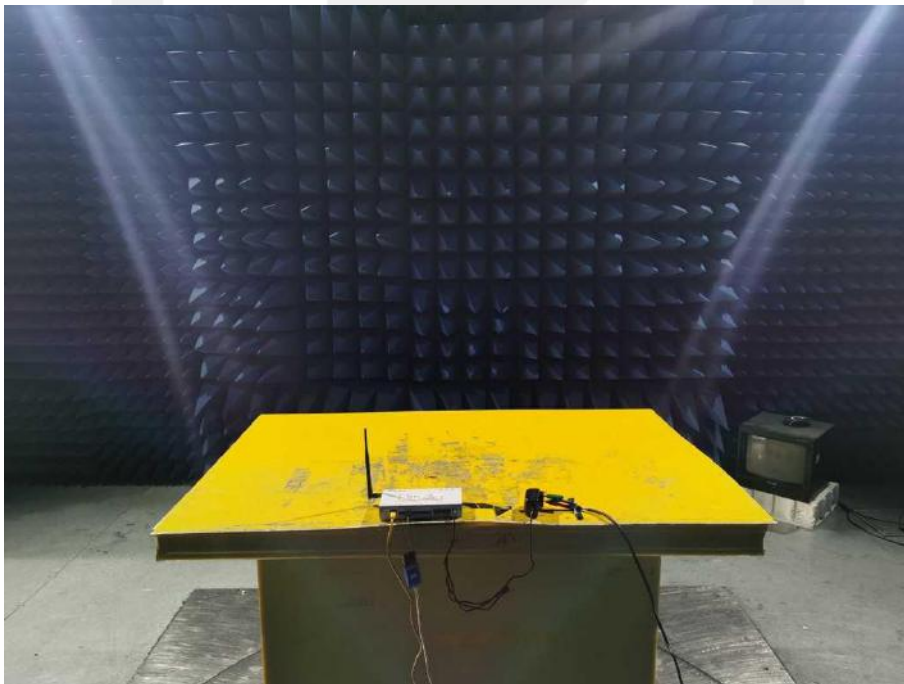
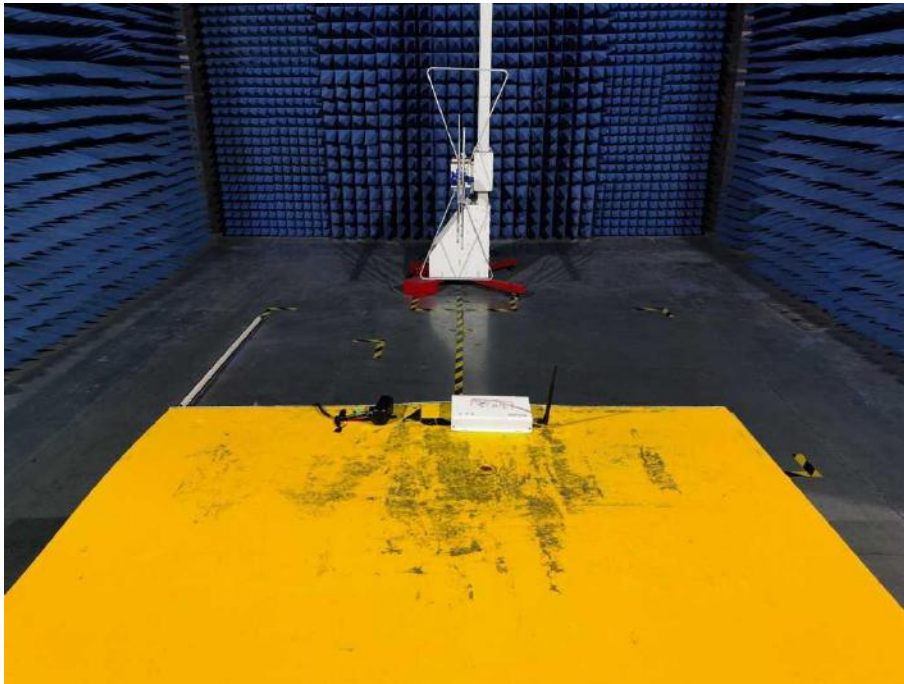

8.4. Photo of Radiation Emission Measurement (Above 1GHz)

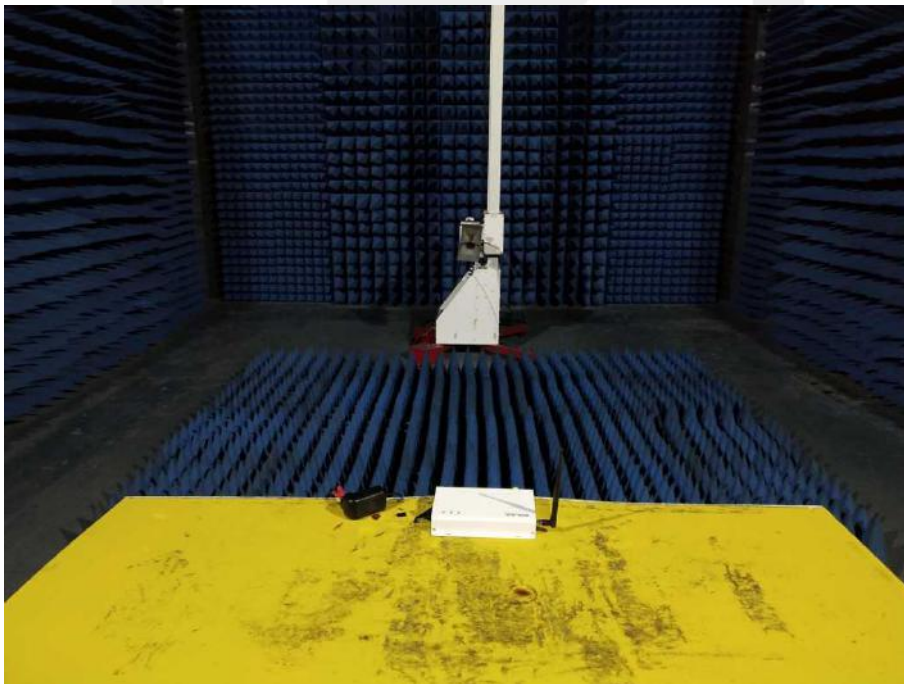
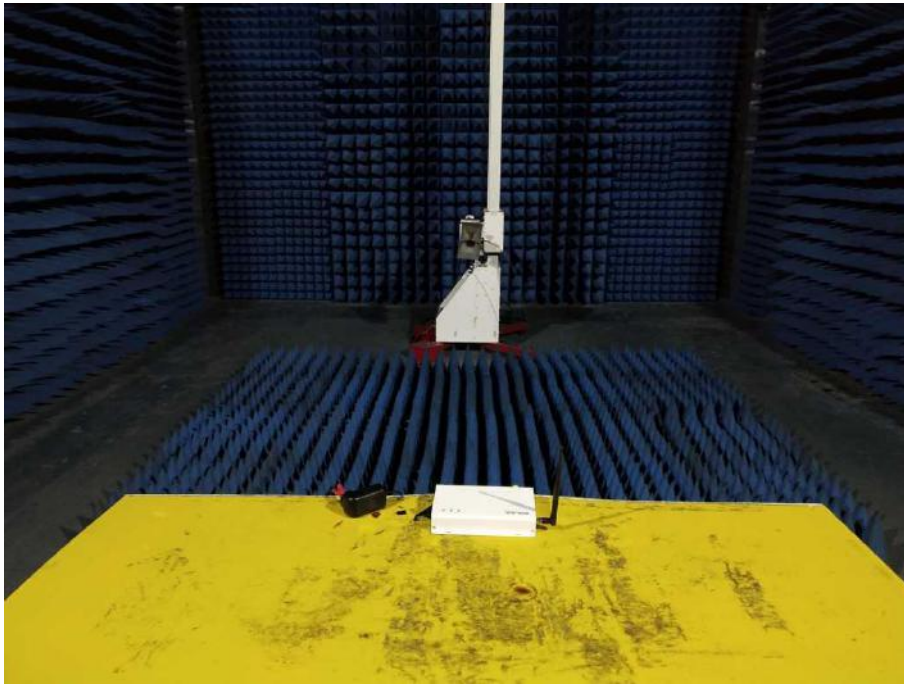



APPENDIX I (Photos of EUT)

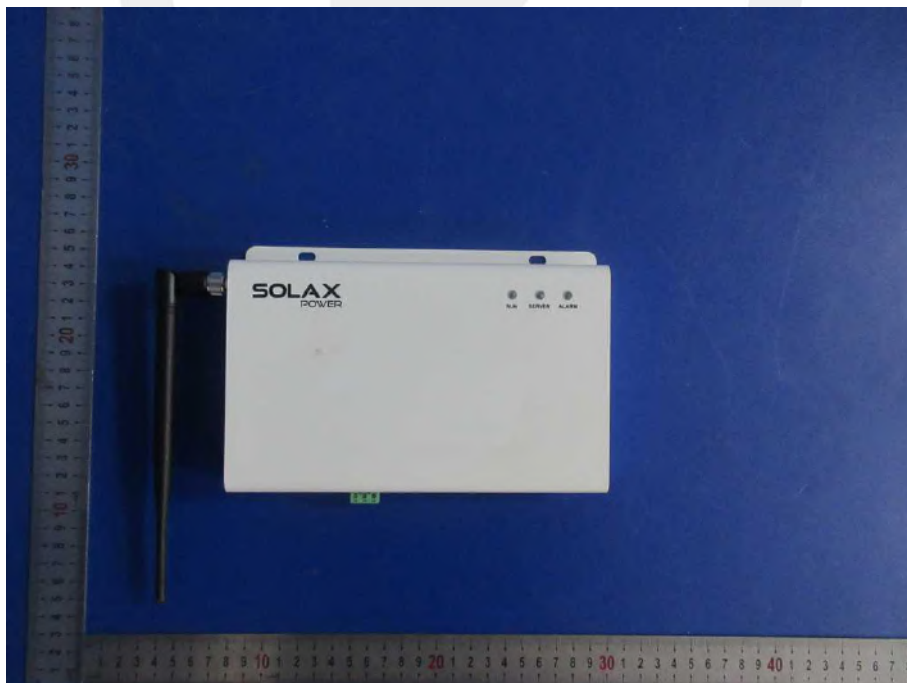
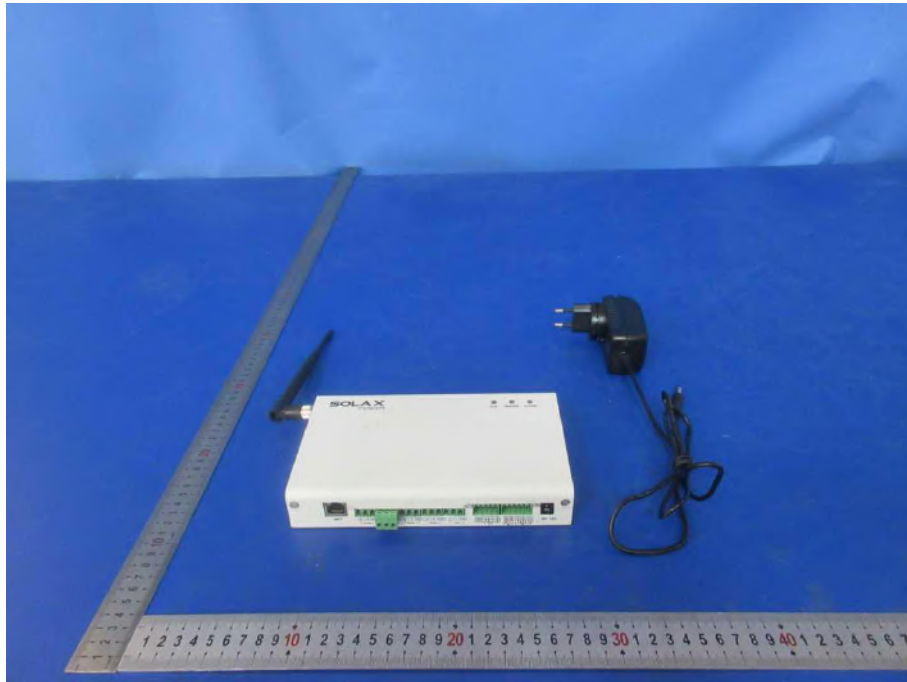

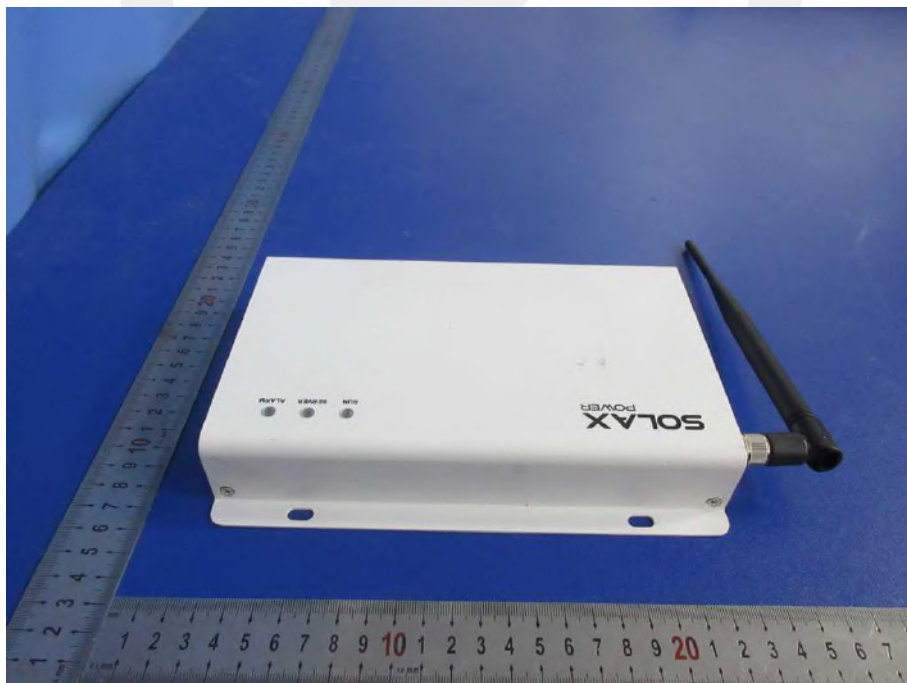

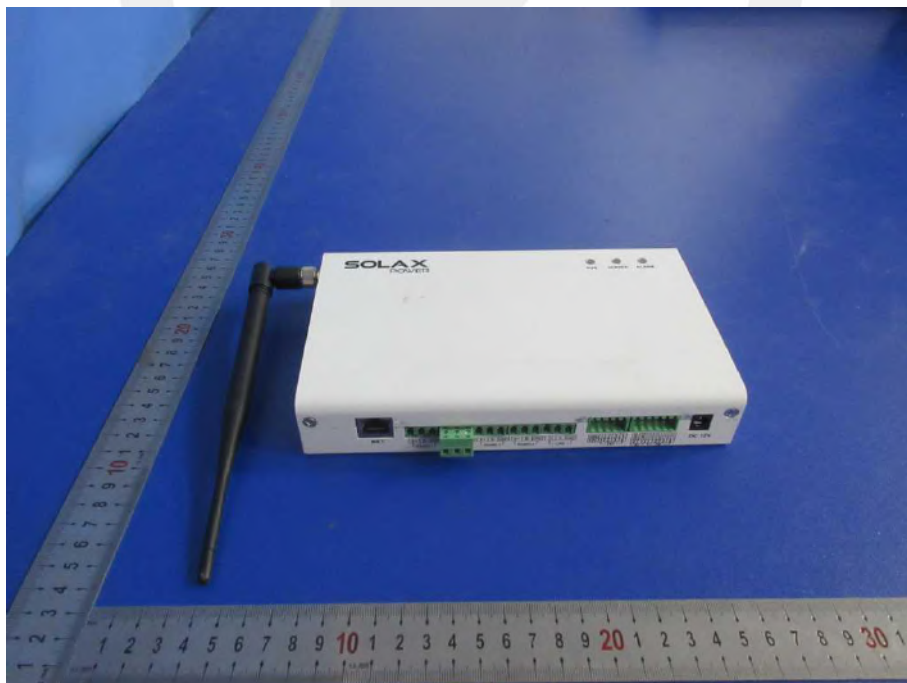

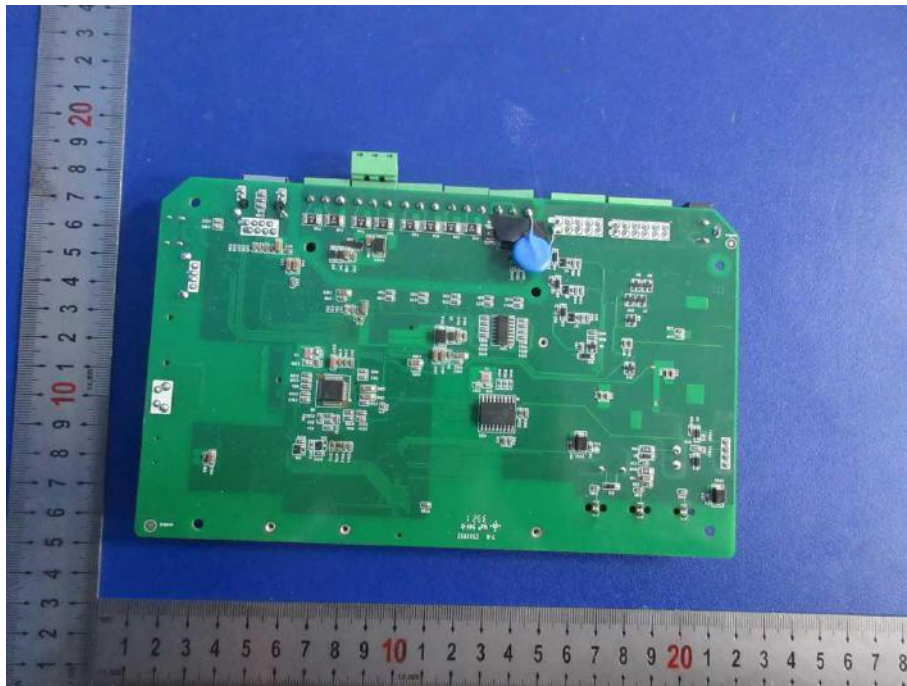

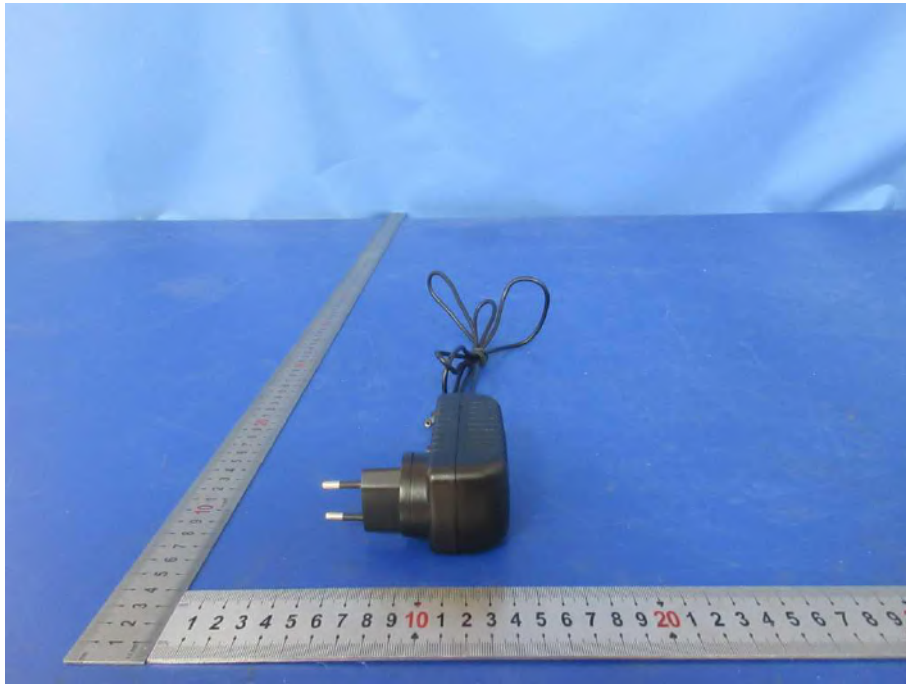

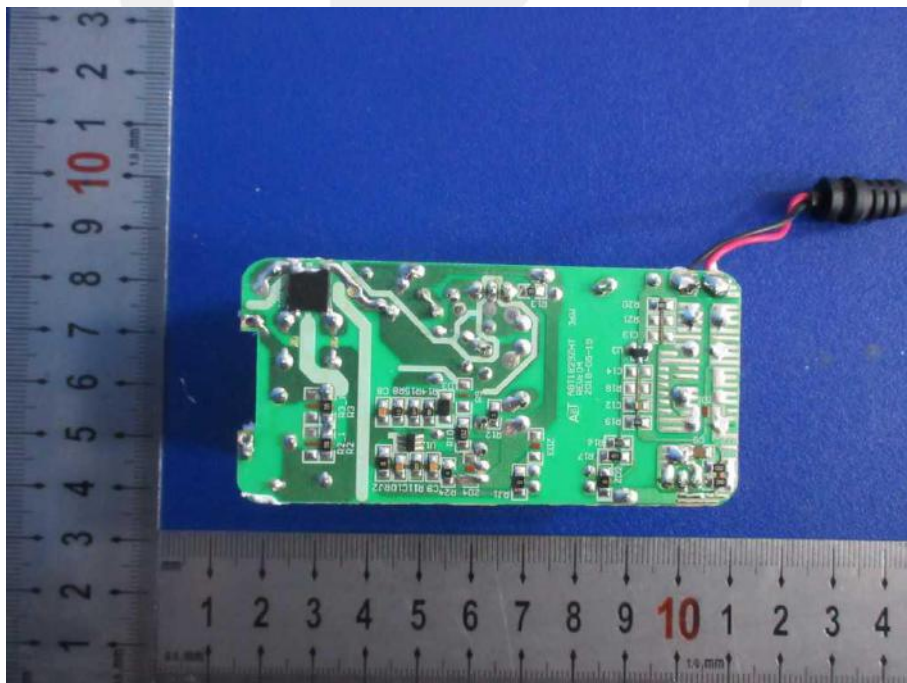



*** End of Report ***

声明

Statement

1. 本报告无授权批准人签字及“检验报告专用章”无效；

This report will be void without authorized signature or special seal for testing report.

2. 未经许可本报告不得部分复制；

This report shall not be copied partly without authorization.

3. 本报告的检测结果仅对送测样品有效，委托方对样品的代表性和资料的真实性负责；

The test results or observations are applicable only to tested sample. Client shall be responsible for representativeness of the sample and authenticity of the material.

4. 本检测报告中检测项目标注有特殊符号则该项目不在资质认定范围内，仅作为客户委托、科研、教学或内部质量控制等目的使用；

The observations or tests with special mark fall outside the scope of accreditation, and are only used for purpose of commission, research, training, internal quality control etc.

5. 本检测报告以实测值进行符合性判定，未考虑不确定度所带来的风险，本实验室不承担相关责任，特别约定、标准或规范中有明确规定的除外；

The test results or observations are provided in accordance with measured value, without taking risks caused by uncertainty into account. Without explicit stipulation in special agreements, standards or regulations, EMTEK shall not assume any responsibility.

6. 对本检测报告若有异议，请于收到报告之日起 20 日内提出；

Objections shall be raised within 20 days from the date receiving the report.